



irsap

ISTITUTO REGIONALE PER LO SVILUPPO DELLE
ATTIVITA' PRODUTTIVE
Ente Pubblico non Economico
L.R. 8/12



REGIONE SICILIANA

Zona Industriale di Dittaino [fraz. di Assoro (EN)]

OGGETTO: Miglioramento e riqualificazione della viabilità consortile esistente -
VIA PASQUASIA - (COD. EN004)

PROGETTO ESECUTIVO AGGIORNATO AL 2017

(art. 23 comma 8 D.Lgs 50/16 - Progetto dell'ex Consorzio ASI di Enna)

<i>Particolari costruttivi</i>	Elaborato	Data progetto
	4	20/12/2011
		1° Aggiornamento
		01/07/2014
	Scala	2° Aggiornamento
varie	14/07/2017	

VISTI E PARERI



Collaboratore alla prima progettazione:
ing. Vincenzo Garofalo

RUP:
dott. in arch. Cristoforo Bentivegna

Il Progettista:
ing. Carmelo Viavattene

SEZIONE STRADALE IN RILEVATO

L = 425,00 m

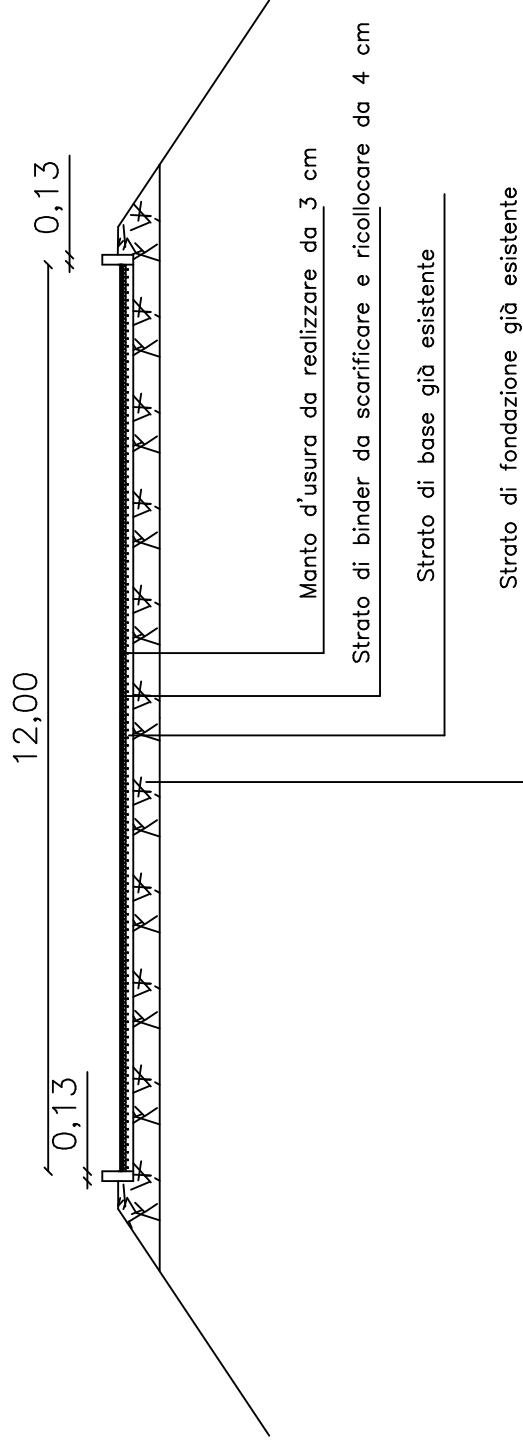

SEZIONE STRADALE IN RILEVATO

L= 315,00 m

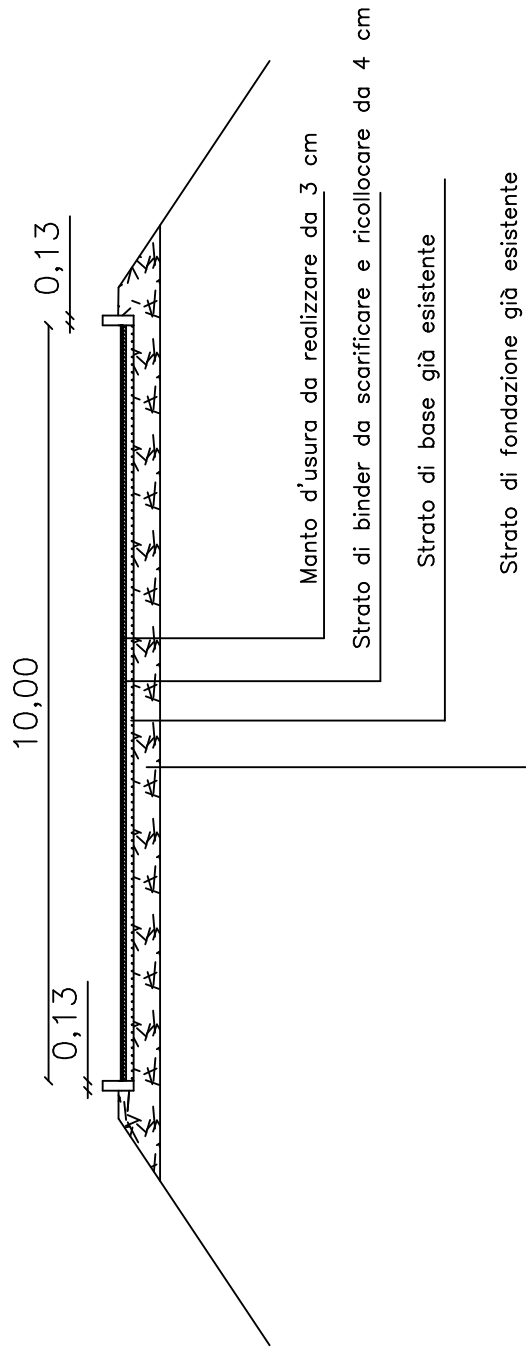

SEZIONE STRADALE IN RILEVATO

L= 480,00 m

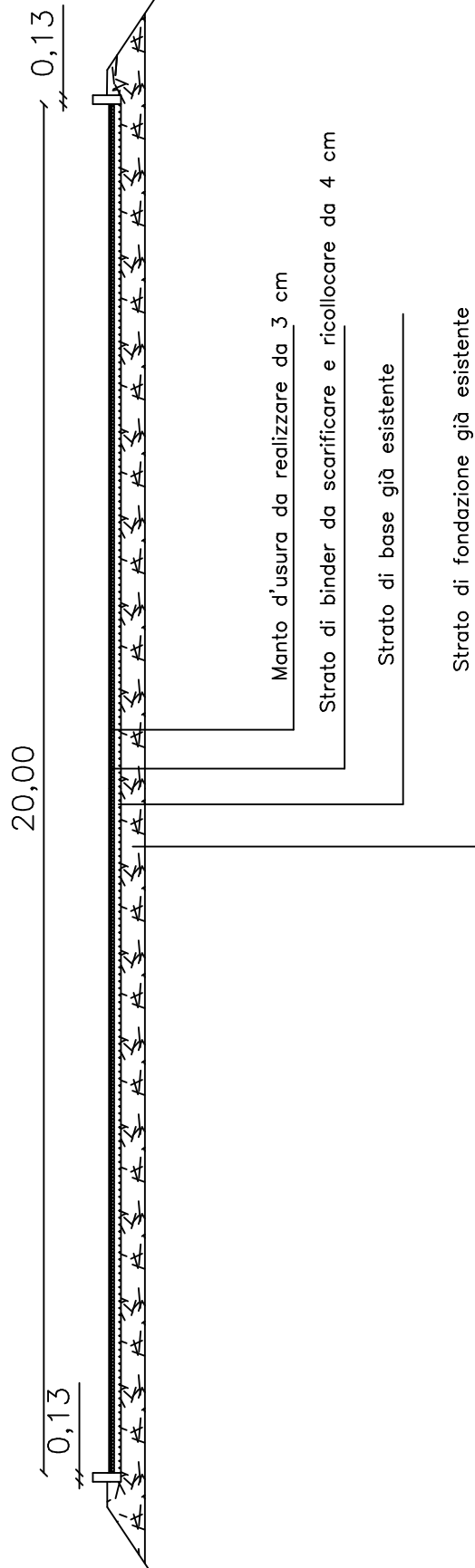

Rotatoria

SEZIONE STRADALE IN RILEVATO

L= 200,00 m

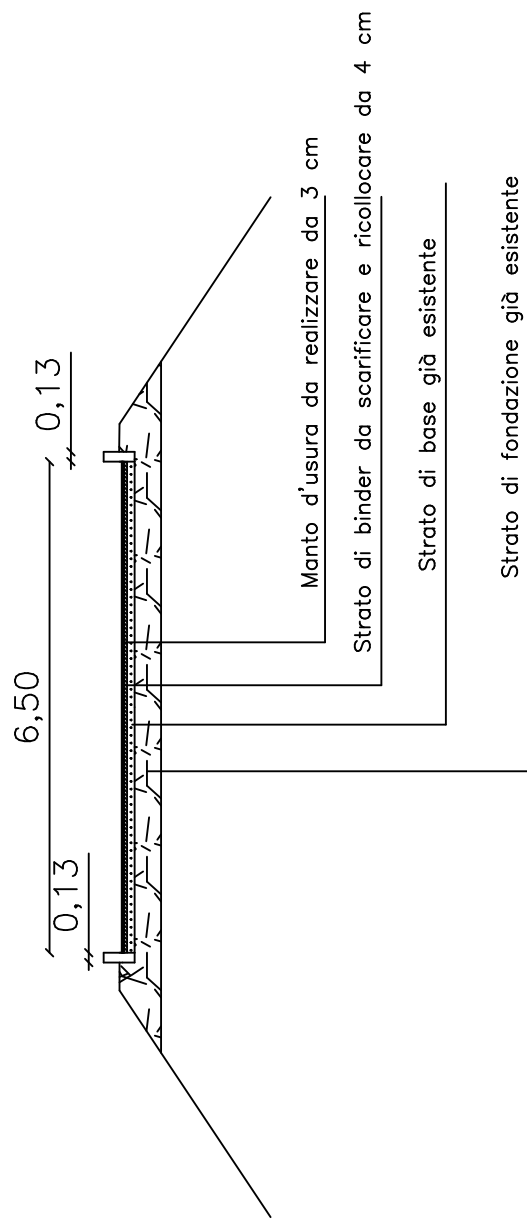

SEZIONE STRADALE IN RILEVATO
L= 640,00 m

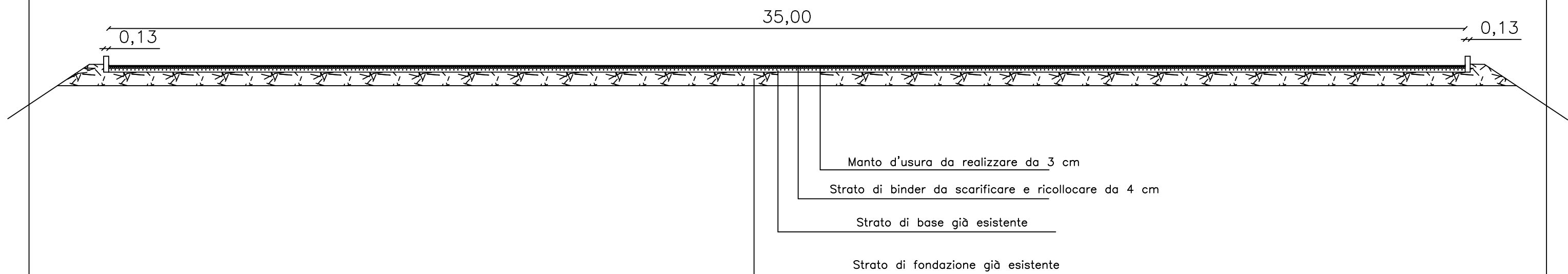

LAMPIONE CON PANNELLO FOTOVOLTAICO

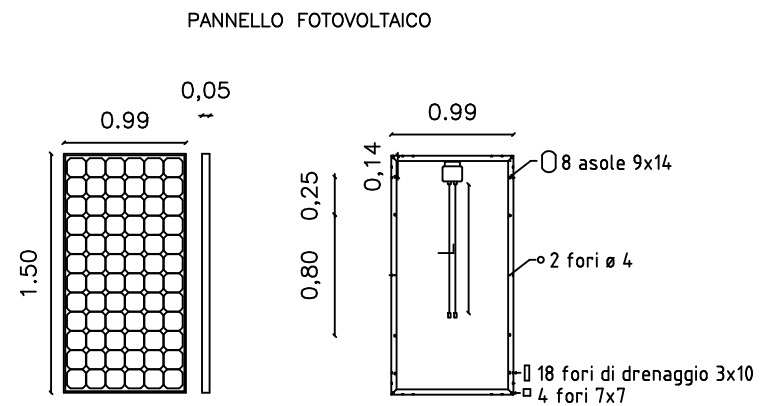
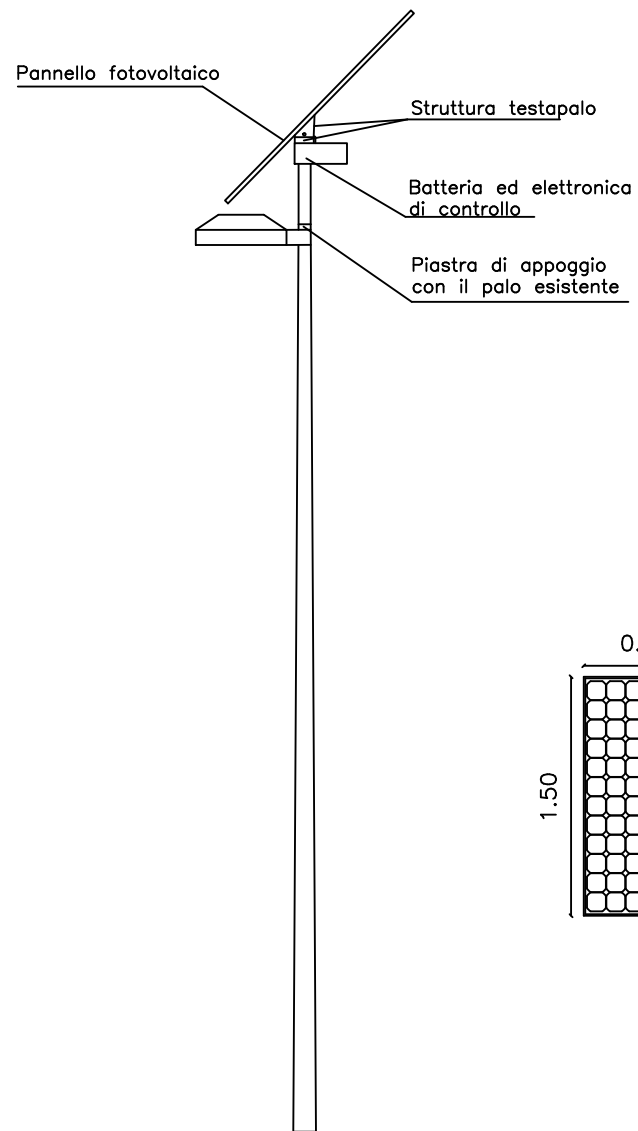

Robinia

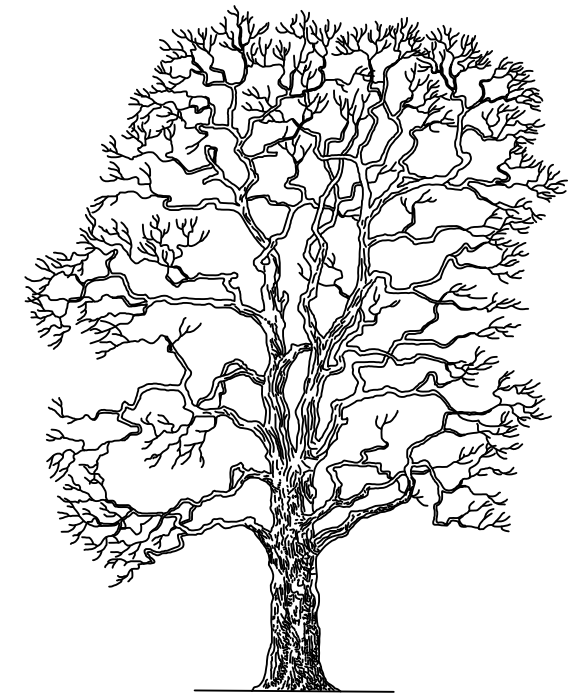

Hm=3,50

CABINA RILEVAMENTO QUALITA' ARIA

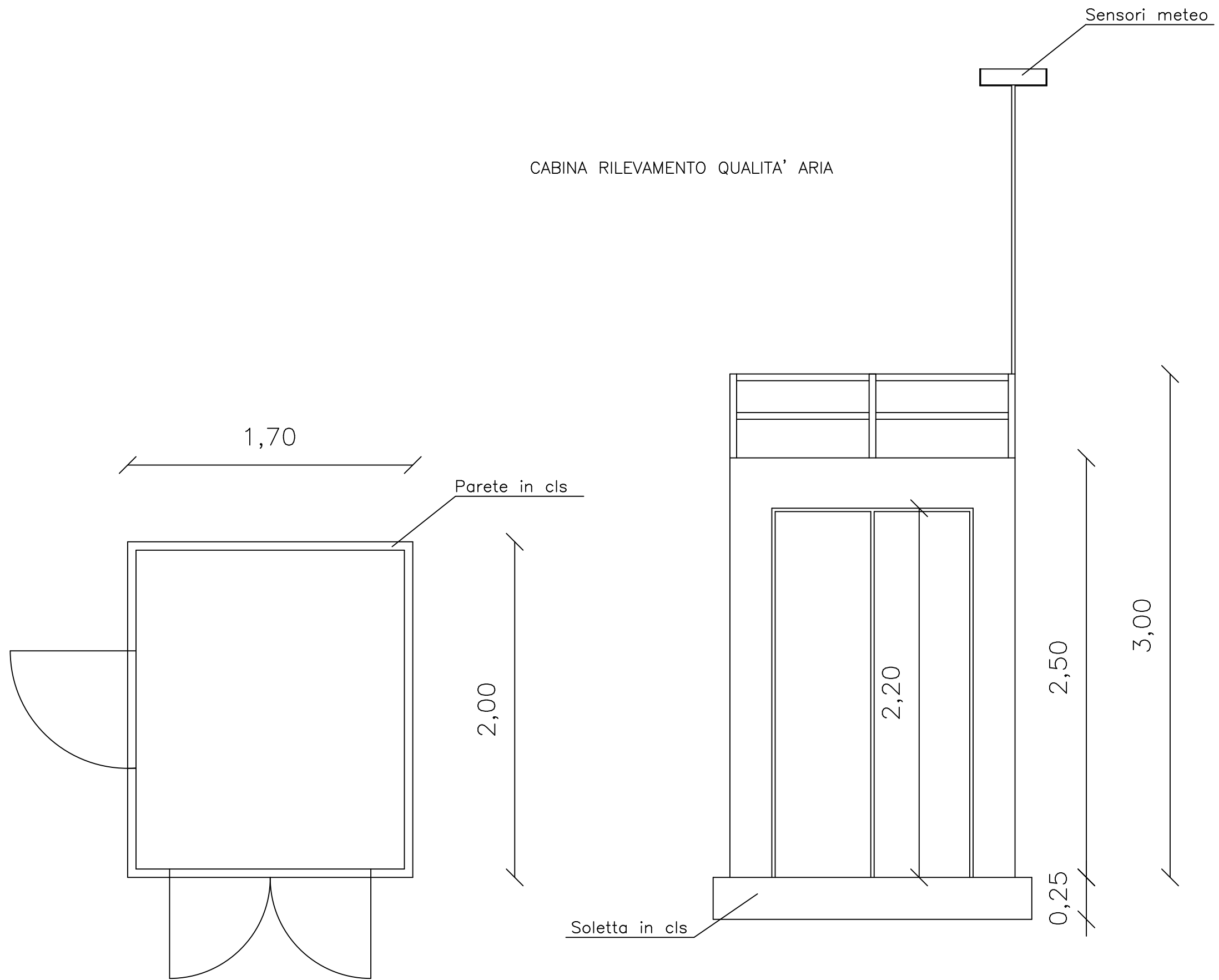

CABINA PER RETE Wi-Fi

